

SECTION V

2022

Technician Team Rules



TECHNICIAN TEAM CONTEST

2022 TECHNICIAN TEAM RULES

TABLE OF CONTENTS

Technician Team Contest Overview.....	1
Multi-Gas Detector Overview.....	1
Air Management Overview.....	1
General Rules.....	2
Judges Information.....	4
Appeals Process.....	4
Discounts.....	5
Written Examination.....	6
Field Set Up Diagram.....	7
Multi Gas Detector General Rules.....	8
MX 6 Multi Gas Detectors.....	10
Drager X-AM 8000* (pending approval).....	11
Air Calculation Worksheet.....	12
Air Measurements General Rules.....	13
Anemometer Rules.....	13
Smoke Tube Rules.....	17
Magnehelic Gauge.....	20

Technician Team Contest Overview

The team will be comprised of two pre-registered persons. The primary disciplines of the 2022 contest are to properly prepare, repair and calibrate a multi-gas detector and to take air readings (air management). Future contests will introduce other disciplines including gas testing proficiency and communications set-up and use. This will all be done at a designated location that is comprised of competition field type set-ups. The two competitors may work together on each discipline or may separate and complete the assigned tasks alone. The total time allotment for the contest will be 30 minutes.

Multi-Gas Detector Overview

The multi-gas detector station will consist of a supplied multi-gas detector. The competitor(s) will be expected to evaluate the instrument(s), repair all of the deficiencies, properly calibrate or functionally (bump) test the instrument, and check for proper action level alarm set points. During this process, the technician team may need to reconfigure the instrument to complete these tasks. The supplied multi-gas detector is to be left in “ready to use” condition. The competitor will then use a team supplied multi-gas detector to take a reading from a “gas box”. This gas box will contain an “unknown” mixture of gases. Each mine rescue team will need to provide their own multi-gas instrument and calibration hood and will be expected to report all required concentrations within acceptable limits: O₂, CH₄, CO, and NO₂.

Air Measurement Overview

The air measurement portion of the technician team contest will consist of stations that will test the competitor’s ability to obtain air readings by using an anemometer, a magnehelic gauge and finally by using a smoke tube. The competitor(s) will be expected to properly execute the complete use of each of these items including measuring the area surveyed. The competitor will be told the final reading and measurements needed to determine the size of the area surveyed in order to ensure a consistent final reading amongst all competitors.

TECHNICIAN TEAM COMPETITION

GENERAL RULES

1. The Technician Team Competition will be held on a simulated mine rescue field and may consist of benching at least one multi-gas instrument and taking various air quantity readings using a vane anemometer, magnehelic gauge and smoke tubes to ensure the field readiness of the team. Thus, with this practical approach at the conclusion of the competition, the technician team's mine rescue team will be prepared to go underground and conduct a successful mine rescue mission.
2. The technician team will consist of two members of the 8-person mine rescue team.
3. Multiple technician teams from a single mine rescue team may enter the event.
4. The technician team members who will be associated with the mine rescue team for the combination award must be designated at the time the mine rescue team is registered.
5. Changes to the designated technician team members may be made up to the time the team members report for lock-up prior to their event. This change will be submitted, in writing, to the Chief Judge of the Technician Team event and/or the Contest Director(s), and must be signed by a representative of the team and the Contest Official.
6. Technician teams not designated to a mine rescue team for the combination award will compete in the Technician Team event, and their scores will only be used to determine their ranking within that event.
7. Registration for the technician team(s) competition will be made during the mine rescue team registration.
8. During registration, the Technician Team will declare which specific multi-gas detector will be used by the team during the working of the problem.
9. The technician team members may work as a team or may separate to perform the tasks assigned during the working of the problem.

10. The Technician Team Competition will be held at a designated location typically on the final day of the competition. Contestants will remain in isolation until they finish the Technician Team Competition or they will be disqualified.
11. For the purposes of identification, participants of the Technician Team Competition must be dressed uniformly, complete with team number, hard hat and permissible cap lamp.
12. After the team verifies that they are ready, the clock will be started by a team member. The technician team may work together or separately to complete the required tasks.
13. At the simulated mine rescue station, the technician team will provide at least one multi-gas instrument, one anemometer, one magnehelic gauge and one smoke tube set complete with aspirator bulbs. The contestants will provide the equipment, tools, and supplies necessary to complete the problem.
14. Thirty (30) minutes will be allowed to complete the competition. There will be a five (5) minute warning given by the judge when the time is about to expire. If the technician team has not completed the competition when time expires, the judges will stop the team activities. They will be scored based on their discounts to that point, including: appropriate discounts for items missed; and appropriate discounts for necessary actions not taken by the technician team to complete the assigned task.
15. All defects in testing and preparation will result in the appropriate discounts.
16. Only judges, contest officials, escorted photographers, and news media approved by the Contest Director(s) will be permitted in the technician team simulated mine rescue station. A separate area will be provided for spectators to observe the teams during competition.
17. In the event of a tie, the written test scores will determine the winner. The total time will be the second tie-breaker.

JUDGES

1. All judges will be trained as prescribed by the Contest Director(s).
2. Judges must stand clear of team members.
3. Prior to the competition, judges will ensure the team's multi-gas instrument(s) contain the deficiencies as per the planned problem.
4. When unplanned deficiencies are encountered, judges will stop the clock, instruct the technician team to turn their backs to their respective area, at which time the judge will correct the unplanned deficiencies. Judges shall instruct the technician team that upon turning back to their area, the clock will restart. If either team member causes the deficiencies, the clock will not be stopped.

APPEALS

1. Technician Teams shall be notified by posting when they may review their score card and written test results. Within one hour of posting, the technician team and team trainer shall report to a designated location. Teams will have 20 minutes to review, prepare, and submit any written protests. Discounts will not be added to the teams field score once the scorecard has been signed. All protests will be considered by the Final Appeals Committee. No additional appeals will be accepted after the 20 minute time limit.
2. Contest rules and other documents used in the contest supporting the appeal will be accepted. Under no circumstance will video tape recordings or photographs be introduced as supplementary material for consideration by the Final Appeals Committee. One of the technician team members or the team trainer will sign the appeal sheet to certify they have reviewed the discounts and verified the totals.
3. If a wireless internet connection is available, the Contest Director(s) may approve an option where the teams can review their results electronically. In those cases, the team must provide an email address that will be used for the review on the form provided at registration. The form must be completed and submitted at registration. Contest officials will email the scorecards, written examination, etc. to the email address on record when they are ready for review. The team will have 45 minutes to review the material starting upon the "read receipt" of the email, but no more than two hours from the time it was posted outside the appeals area, and email any protests back to the Contest Officials.

DISCOUNTS

1. Discounts will not be added to the technician team score once the judges have signed their discount sheets following a review with team members. This does not preclude changes due to administrative errors or a misapplication of a rule.
2. Technician Teams will not be discounted more than once for any one mistake in the same segment of the competition where such mistakes may qualify under more than one discount. Judges will confer and assess the highest single discount.

WRITTEN EXAMINATION

1. During isolation, contest officials will administer a written examination to the two technician team members.
2. The written examination will consist of 15 multiple choice questions taken from the review questions and glossaries that are in Modules 2 - Mine Gases and Module 3 - Mine Ventilation of the "draft" IG 115. Written Examination questions may also be taken from the checking and testing procedures for the **Dräger X-am 8000* pending approval** and MX6 iBrid Multi-Gas Monitors. (The team members will only be tested on the procedures for the specific multi-gas detector declared by the team at registration).
3. Answers will be multiple choice with only three choices. "None of the above" will not be used as one of the choices. The answers will be verbatim from the text of the Modules and instrument checking/testing procedures referenced in Item #2 above and will not be intentionally misspelled.
4. A maximum of 20 minutes will be allowed for the team members to take the test.
5. Team members taking the written examination will not be permitted to take any written material or information into the testing area.
6. No wireless communication or electronic device, including Apple watches or similar devices, will be permitted in the testing area.
7. There will be no discussion during the time that written examinations are being taken.
8. Team members from the same team will not be permitted to sit at the same table while taking the written examination.

TYPICAL FIELD SET UP

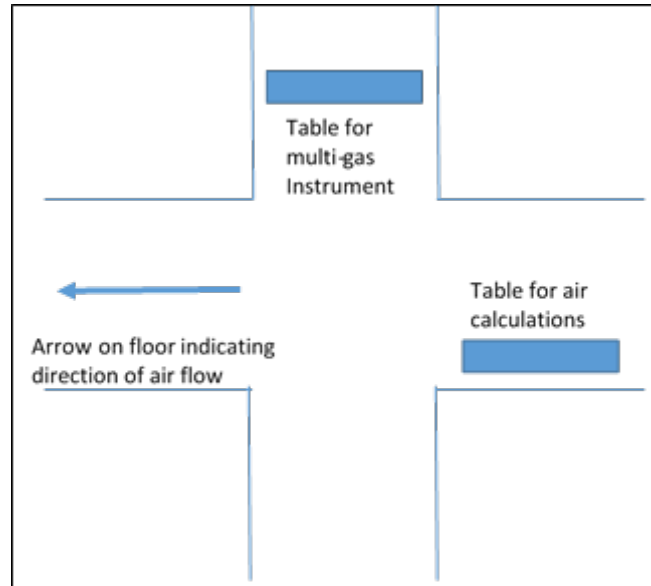
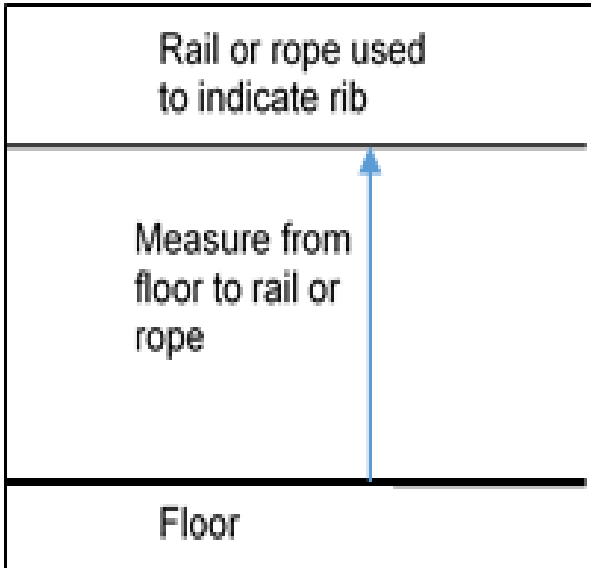

Example of field set up and use of arrow to indicate airflow - An arrow on the floor will be used to indicate the direction of airflow to be measured

Determining Area (Anemometer and Smoke Tubes)

Contestant(s) will take a measurement of the area to be tested. Both the width and the height of the area must be measured in order to determine the square footage of the area. After the measurements have been taken by the contestant(s) a judge will provide the contestant(s) with the width and height to be used for the square footage calculations. (This is being done to ensure consistency). (Example---18 feet wide x 6 feet high is $18 \times 6 = 108$ square feet)

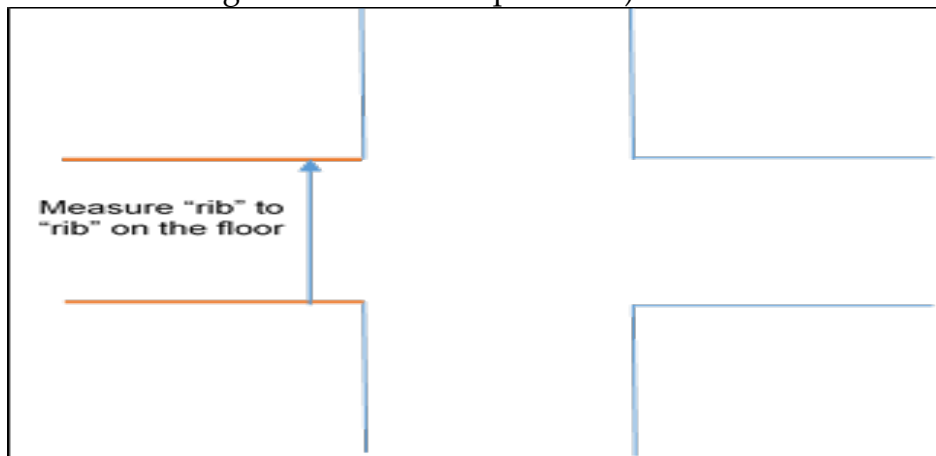

TECHNICIAN TEAM COMPETITION MULTI-GAS INSTRUMENT CHECKS/PROBLEM DIAGNOSIS

MULTI-GAS DETECTOR GENERAL RULES

1. The two Technician Team members will be escorted to the designated field. The team will find a table that has the needed supplies and equipment to perform the multi-gas instrument portion of the contest.
2. The technician team must be familiar with the respective multi-gas instrument manufacturer's current operations manual, handbook, and/or instructional videos. (Note: these videos may be found on the individual manufacturers' websites).
3. The multi-gas instrument(s) given to the technician team may have multiple bugs or problems consisting of any of the following but not limited to:
 - Missing and/or needed sensors
 - Failed sensors
 - Miscalibrated sensors
 - Dead or incorrect batteries
 - Incorrect alarm and calibration points
 - Missing parts
 - Defective parts
4. The technician team will be expected to evaluate the instrument(s), repair all of the deficiencies, properly calibrate or functional (bump) test the instrument(s), and check for proper action level alarm set points. During this process, the technician team may need to reconfigure the instrument(s) to complete these tasks.
5. The technician team will also be required to bring a multi-gas instrument to the Team Technician contest. For contest purposes, multi-gas instruments used by the teams during the field and technician team competitions must meet the requirements of 30 CFR 49.16(a)(6) and 30 CFR 49.6(a)(6). Gas testing proficiency will be conducted during the multi-gas instrument portion of the competition. At the designated multi-gas instrument contest location, the team will find a gas box (gas cylinder and tubing) containing an "unknown" mixture of gases. Each mine rescue team will need to provide their own multi-gas instrument and calibration hood and will be expected to report all required concentrations within acceptable limits: O₂, CH₄, CO, and NO₂.

6. The technician team may return to correct any uncorrected deficiencies at any time within the time limit.
7. Twenty (20) discount points per alarm point will be assessed for any incorrectly set alarms.
8. Twenty (20) discount points will be assessed for each instance of incorrect procedure or equipment use during calibration.
9. No discounts will be assessed for replacing non-deficient sensors, as long as the resulting calibration(s) and alarm points are correct.
10. Fifteen (15) discount points will be assessed for each incorrect gas concentration identified when the team's instrument is subjected to the "unknown" gas mixture, as follows:
 - Oxygen readings are considered to be correct if within plus or minus 0.5% by volume;
 - Methane readings are considered to be correct if within plus or minus 0.2% by volume (LEL readings are not acceptable);
 - Carbon Monoxide readings are considered to be correct if within plus or minus 10% of the actual value present; and
 - Nitrogen Dioxide readings are considered to be correct if within plus or minus 3 ppm of the actual value present.
11. Five (5) discounts will be assessed for each deficiency (bug) not corrected.
12. For completion, the instrument(s) must be fully assembled, operating, and properly configured within the allowed time. If the team technician does not leave the instrument(s) in this "ready-for-use" condition, a five (5) point discount will be assessed.

Note: "Ready for Use" means that the instrument is left "on" with the peaks cleared

MX6 iBrid Multi-Gas Detectors

A. Checking instrument:

1. Turn the instrument on by pressing and holding the center [Enter] navigation button on the lower front of the instrument for at least 3 seconds.
2. After power up, a series of startup screens are displayed on the LCD.

STARTUP SELF TEST - Depending on configuration, startup screens may be displayed.

NORMAL OPERATION MODE - The types and readings of all installed sensors are displayed.

BATTERY STATUS - Under the main menu [VIEW] option, select [BATTERY] to view the battery status.

3. Visually check instrument for damage. Visually inspect the LCD display after it stabilizes.

B. Testing for carbon monoxide (CO), methane (CH₄), oxygen (O₂) and Nitrogen Dioxide (NO₂):

1. When activated, instrument detects and measures concentration of carbon monoxide, methane, oxygen and nitrogen dioxide in the ambient air continuously and simultaneously.
2. All gas measurements are revealed on the LCD and all are displayed simultaneously.
3. In case of an alarm, the sensor(s) in alarm will be highlighted on the display.

Carbon monoxide (CO) and nitrogen dioxide (NO₂) are measured and displayed in parts per million (ppm), methane (CH₄) and oxygen (O₂) are displayed in percent by volume (%Vol).

Dräger X-am 8000 * (Pending Approval)

A. Checking Instrument

1. Turn the instrument on by pressing and holding the “OK” button on the lower front of the instrument for 3 seconds.
2. After power up, a series of startup screens will be shown on the display.

STARTUP SELF TEST – Startup screens showing each sensor and its alarms settings will be displayed. This can be bypassed by pressing the down-arrow button on the bottom right of the meter.

NORMAL OPERATON MODE – The sensor type, measuring unit, and reading for all installed sensors is displayed.

BATTERY STATUS – On the main display screen, in the upper right corner, the battery status is shown with a battery icon and a remaining capacity in percent (%).

3. Perform a visual check of the meter for damage and check the gas readings on the LCD display when the have stabilized.

B. Testing for carbon monoxide (CO), methane (CH₄), oxygen (O₂) and Nitrogen Dioxide (NO₂):

1. When the instrument is powered on, it continuously monitors for the presence of carbon monoxide, methane, oxygen and nitrogen dioxide simultaneously in the ambient air.
2. All gas measurements are shown on the LCD and all are displayed simultaneously.
3. In case of an alarm, the sensor(s) in alarm will be highlighted on the display.

Carbon monoxide (CO) and nitrogen dioxide (NO₂) are measured and displayed in parts per million (ppm), methane (CH₄) and oxygen (O₂) are displayed in percent by volume (% Vol).

Air Calculation Worksheet

A worksheet will be provided and is to be completed by each contestant to document final air readings for the anemometer, smoke tube and magnehelic portions of the contest.

The completed worksheet will be returned to the judge(s) at the completion of the problem.

Smoke Tube Reading

Pull 10 foot out on the tape measure in the entry and observe the time it takes for a puff of smoke to travel the length of the 10 foot tape measure in each of four quadrants;

1st quadrant ____ seconds *Space for calculations*

2nd quadrant ____ seconds

3rd quadrant ____ seconds

4th quadrant ____ seconds

Total ____ / 4 = average time

Distance in Feet (10) / Average time = _____ feet per second (FPS).

FPS x 60 (seconds/minute) = _____ FPM

Entry width ____ x Entry height ____ = _____ area in square feet

Area ____ x FPM velocity ____ = _____ CFM

Anemometer Reading

Entry width ____ x Entry height ____ = _____ area in square feet

FPM reading ____ + or - correction factor = _____ corrected FPM

Area ____ x (corrected) FPM velocity ____ = _____ CFM

Space for calculations

Magnehelic gauge

Record dial reading _____ Positive _____ Negative _____

Air Measurement General Rules

TECHNICIAN TEAM COMPETITION AIR MEASUREMENT GENERAL INFORMATION AND CONTEST RULES

ANEMOMETER:

Contestant(s) will provide their own anemometer

Contestant(s) will provide their own tape measure

Contestant(s) will provide their own pen or pencil

Contestant(s) will provide their own timing device that complies with the general contest rules

Contestant(s) may provide a "simple" calculator

Contestant may provide a "wand" extension for their anemometer

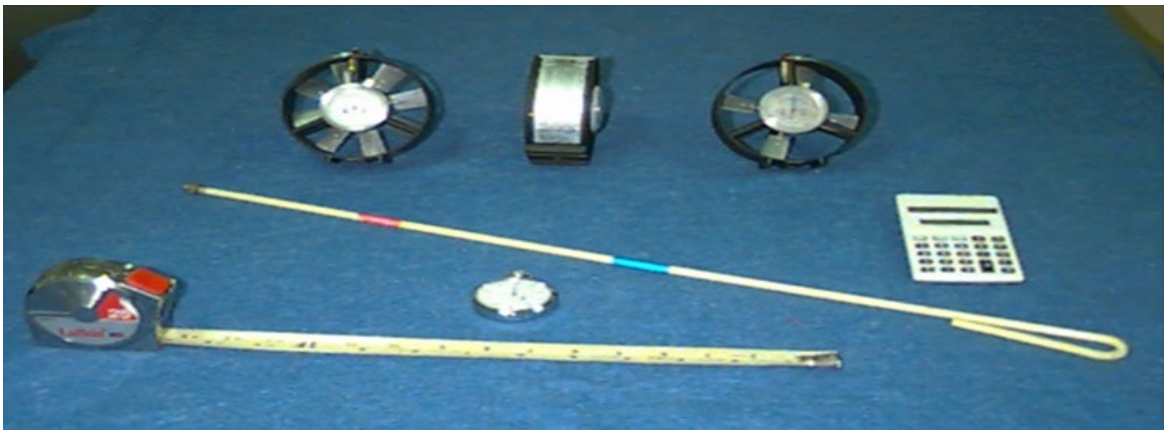

Contestant(s) failing to provide the items above will be discounted per applicable rule.

Failure of the contestant(s) to provide anemometer, measuring tape and timing device will result in one point being discounted for each item.

Contestant(s) will be required to take air readings with an Anemometer.

Contestant(s) will give a brief description of the anemometer (how to zero and turn on the anemometer).

Example: An anemometer is a small sort of windmill with a mechanical counter for recording the number of revolutions caused by the moving air current. It is used to measure air velocities of over 120 feet per minute. The anemometer must be turned in the correct direction to allow the airflow to come into the back (opposite side of the dial) to get a correct air reading. The airflow will be

shown as an arrow on the field with the point of the arrow pointing in the direction of the airflow if the contestant has the anemometer turned in the wrong direction they will be discounted per applicable rules.

Contestant(s) failing to give a brief description of how an anemometer functions will be discounted per applicable rule:

Failure to give a brief description of the anemometer (how to zero and turn on the anemometer) will result in one point being discounted.

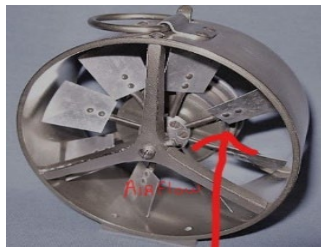

Illustration of (Back) of Anemometer Illustration of Dial Side (Front) of Anemometer

Contestant(s) will take a measurement of the area to be tested. Both the width and the height of the area must be measured in order to determine the square footage of the area. After the measurements have been taken by the contestant(s) a judge will provide the contestant(s) with the width and height to be used for the square footage calculations.

Contestant(s) failing to correctly calculate the area will be discounted per the applicable rule.

Failure to measure both the width and the height of the area will result in one discount.

Procedure to be used for using the anemometer and traversing the airway

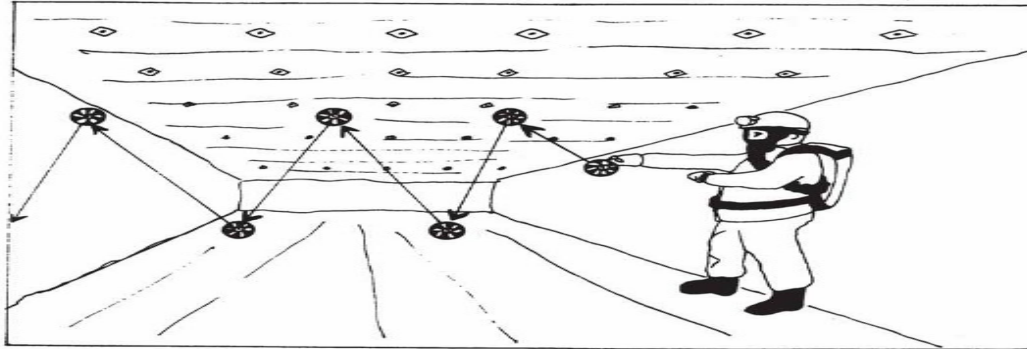

Contestant(s) failing to correctly zero the anemometer will be discounted per the applicable rule.

Failure to correctly zero the anemometer result in one discount.

2. Stand with your back to one rib and hold the anemometer in a vertical position in front of you at full arm's length. The anemometer should be positioned so that the air current will enter the rear or back of the anemometer. Your free arm should be kept close to your body.
3. Turn the anemometer on by pulling the upper lever toward you. Slowly walk across the entry while raising and lowering the anemometer to obtain an average air reading. Be sure to keep the anemometer out in front of you (to decrease resistance as much as possible). Travel time will be paced so that the traverse of the airway will end at the starting point by the end of the one minute traverse.

Contestant(s) failing to properly traverse the entry will be discounted per the applicable rule

Failure to properly traverse the entry will result in one discount.

4. At the end of one minute, turn off the anemometer and read the dials and at this point, a reading will be given to the contestant(s) by a judge. This reading will have to be corrected by using the manufacturer's table of corrections for the various velocity readings.

Contestant(s) taking an air reading for less than or more than 1 minute (60 Seconds) will be discounted per the applicable rule.

Failure to take a 1 minute reading in the area will result in one discount.

Contestant(s) failing to incorporate the correction factor will be discounted per the applicable rule.

Failure to incorporate correction factor will result in one discount.

Reading (fpm)	Correction	Reading (fpm)	Correction
50	+15	500	-5
75	+15	550	-8
100	+14	600	-10
125	+14	700	-15
150	+14	800	-20
175	+13	900	-25
200	+12	1000	-30
250	+11	1200	-35
300	+10	1400	-45
350	+5	1600	-50
400	0	1800	-60
450	-2	2000	-65

Correction chart to be used for contest

Contestant(s) will now calculate the air reading for the area (air reading must be calculated and submitted to the judge). **(EXAMPLE: The anemometer reading is 215 with a correction factor of +12 which = 227 ft/min, the area was 108 square feet thus $227 \text{ ft/min} \times 108 \text{ sqft} = 24,516$ cubic feet per minute)**

Contestant(s) failing to correctly calculate the air reading will be discounted per the applicable rule.

Failure of the Contestant(s) to correctly calculate the air reading for the area (air reading must be calculated with pencil or pen and submitted to the Judge) will result in one discount.

SMOKE TUBES:

- Contestant(s) will be required to take air readings with a smoke tube.
- Contestant(s) will provide the Smoke Tubes and Aspirating Bulb
- Contestant(s) will provide Tape Measure
- Contestant(s) will provide their own pen or pencil
- Contestant(s) will provide a Timing Device that complies with the General Contest Rules
- Contestant(s) may provide a “simple” calculator

Contestant(s) failing to provide the above items will be discounted per the applicable rule.

Failure by the Contestant(s) to provide smoke tubes with aspirator bulb, measuring tape and timing device will result in one discount per item not provided.



Procedures for using smoke tubes

1. Measure off a distance in a relatively straight and uniform airway. Ten (10) feet will be the distance for this measurement.
2. The Contestant(s) with the smoke tube will stand at the upwind point of the measured distance, and station one person with a stopwatch at the downwind point. (FOR CONTEST PURPOSES A CONTEST OFFICIAL WILL FILL THIS ROLL)
3. The Contestant(s) with the smoke tube then simulates releasing a smoke cloud at each quadrant point within the airway. The person (FOR CONTEST PURPOSES A CONTEST OFFICIAL WILL FILL THIS ROLE) with the stopwatch then must time each cloud from the moment it is

released until it reaches the downwind point. The measurements are taken separately for each of the quadrants until all 4 quadrants have been completed.

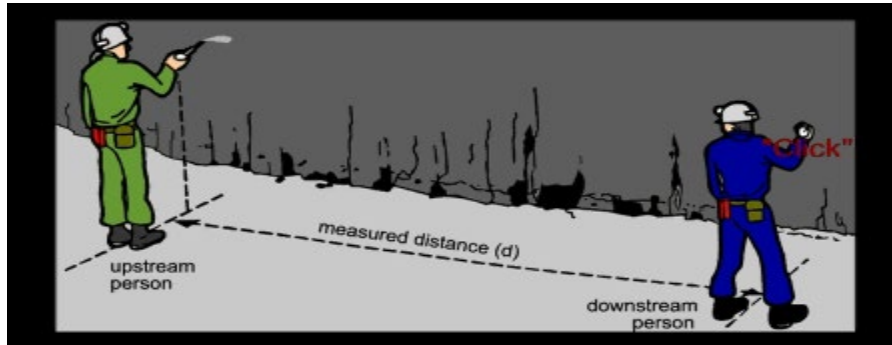

Contestant(s) failing to measure off a distance of 10 feet will be discounted under the applicable rule.

Failure to measure off a distance of 10 feet will result in one discount.

Contestant(s) will determine the area to be tested in square feet. To determine square feet the Contestant(s) will measure the height and width of the area to be tested and multiply the height and width to arrive at the square footage. Example- 8 feet high by 20 feet wide: $8 \times 20 = 160$ square feet.

If a Contestant(s) fails to determine the area they will be discounted per applicable rules.

Failure to take measurement of area to be tested will result in one discount

Explanation of process

Contestant(s) will verbally explain how smoke will be released and timed through each of the four quadrants (**The contestant(s) will not "break" the smoke tube**).

If a Contestant(s) fails to explain how smoke will be released they will be discounted per applicable rule:

Failure of contestant(s) to verbally explain how smoke will be released and timed through each of the four quadrants will receive one discount.

Contestant(s) will apply smoke and time the travel time of the smoke to each of four (4) quadrants: Upper Right, Lower Right, Upper Left, Lower Left, testing each quadrant individually.

If a Contestant(s) fails to apply smoke and time the travel time of the smoke they will be discounted per applicable rule.

Failure of contestant(s) to apply smoke will result in one discount for each of the quadrants. Up to four total discounts may be applied.

For uniformity the judge will give the team the travel time of the smoke for each quadrant

Contestant(s) will calculate smoke air reading for the area. An example of this calculation is below.

Contestant(s) failing to correctly calculate the air reading will be discounted per applicable rule.

Failure to calculate smoke air reading for the area (air reading must be calculated and submitted to the judge) will result in one discount.

<p>1st quadrant = 10 seconds 2nd quadrant = 13 seconds 3rd quadrant = 11 seconds 4th quadrant = 12 seconds Total = 46 seconds</p> <p>$46 / 4 = 11.5 \text{ seconds (average)}$</p>	<p>18 feet (entry width) <u>x 7 feet (entry height)</u> = 126 Area in Square Feet</p>
<p>$\frac{10 \text{ feet (distance)}}{11.5 \text{ seconds (average)}} = 0.87$</p> <p>0.87 <u>x 60 seconds</u> = 52 fpm (velocity)</p>	<p>126 square feet (area) <u>x 52 fpm (velocity)</u> = 6552 cfm (volume)</p>

Method to properly calculate air readings when using smoke tubes

MAGNEHELIC GAUGE:

Contestant(s) will provide the Magnehelic gauge and hoses

Contestant(s) will provide a device for zeroing the Magnehelic gauge

Picture of a Magnehelic

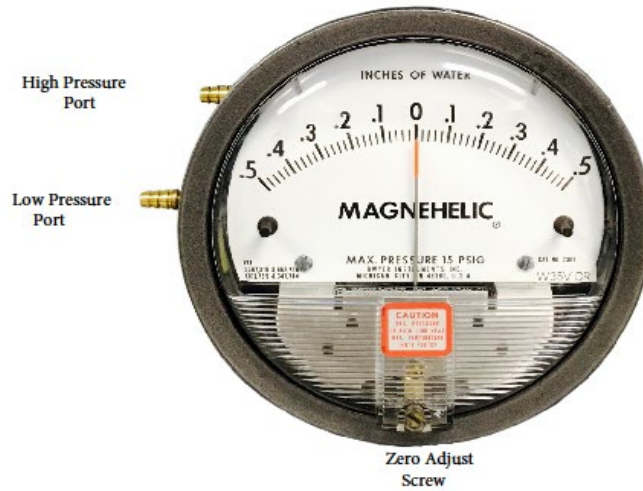

Schematic of a Magnehelic Gauge

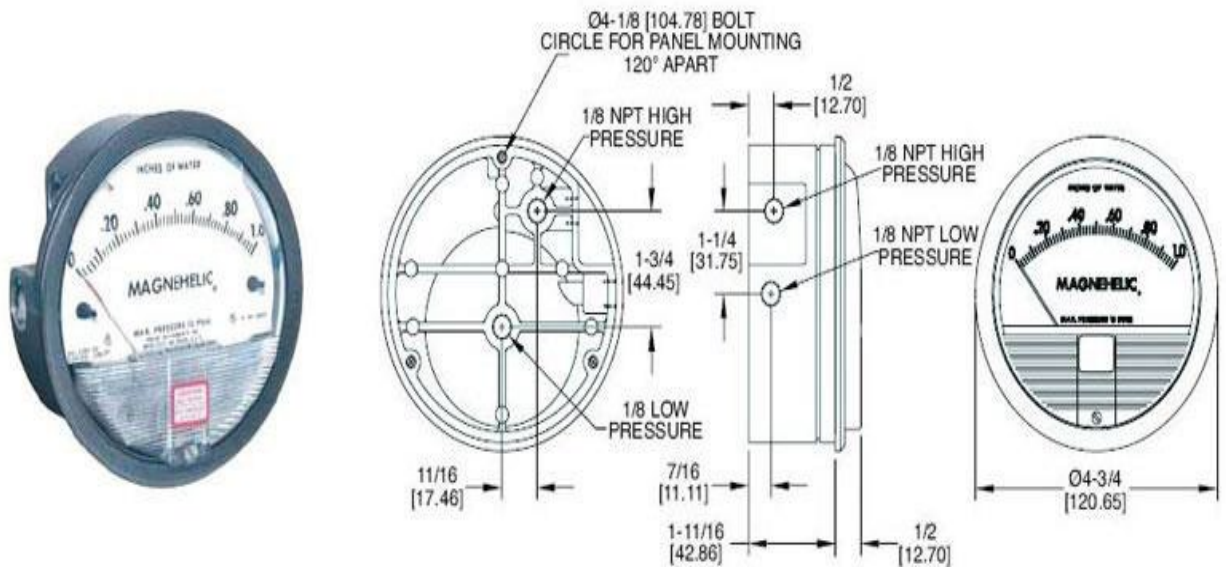

Dimensions, Standard Series 2000 Magnehelic* Pressure Gages.
(Slightly different on medium and high pressure models)

Operation of the Magnehelic Gauge

Zero the gauge by setting the indicator pointer exactly on the zero mark, using the external adjust screw on the cover (bottom)

Positive Pressure

Connect tubing from the source of pressure to the high-pressure port. Vent low pressure port to atmosphere.

Negative Pressure

Connect tubing from source of vacuum or negative pressure to low pressure port. Vent one or both high-pressure ports to atmosphere

Differential Pressure

This will be the number indicated on the dial and may be either positive or negative

Contestant(s) failing to provide the items above will be discounted per applicable rule.

Failure to provide a Magnehelic gauge and necessary port hoses and fittings will result in one discount.

Contestant(s) will explain what the Magnehelic gauge is used to measure.

Contestant(s) failing to explain what a Magnehelic gauge measures will be discounted per applicable rule.

Failure to explain what the Magnehelic gauge is used to measure will result in one discount.

Contestant(s) will demonstrate how to zero the Magnehelic gauge.

Contestant(s) failing to demonstrate how to zero the Magnehelic will be discounted per applicable rule.

Failure to demonstrate how to zero the Magnehelic gauge will result in one discount.

For contest purposes, all returns will be low pressure and all intakes will be high pressure. Contestant(s) will be given information on their location and area to be tested.

Contestant(s) will connect the hoses to Magnehelic properly and simulate the reading.

Contestant failing to connect the hoses to the proper port will be discounted per applicable rule.

Failure to connect the hoses to Magnehelic properly and simulate the reading will result in one discount.

Judge will have a preset Magnehelic gauge or a picture of a preset Magnehelic gauge to simulate the correct reading.

Contestant will give and explain the proper reading of the Magnehelic to the judge (positive or negative pressure should be included in the explanation).

Failure of the Contestant(s) to state the correct reading on the Magnehelic will result in one discount.